

# The TruWood® Collection

## Coverage Chart and Product Profiles



1/2 in. COTTAGE LAP® SIDING



7/16 in. OLD MILL® PANEL SIDING



1/2 in. SELF-ALIGNING LAP SIDING



1/2 in. SURE LOCK™ LAP SIDING\*



1/2 in. CHANNEL RUSTIC™ LAP SIDING

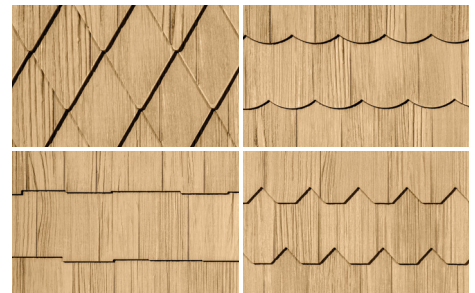

1/2 in. DESIGNER SHAKE® LAP SIDING



1/2 in. ADOBE™ PANEL SIDING



1/2 in. 808 OLD MILL® PANEL SIDING



OLD MILL® SHINGLE LAP SIDING

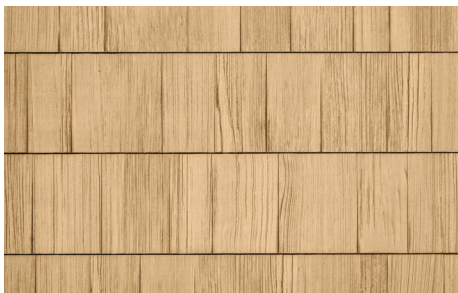

1/2 in. CEDAR SHAKE LAP SIDING



1/2 in. SURE LOCK™ SIX COTTAGE LAP® SIDING\*



REVERSIBLE AND NON-REVERSIBLE TRIM

**TruWood**<sup>®</sup>  
Collins Products LLC SIDING | TRIM

- Create distinctive homes with TruWood Siding and Trim
- EcoGuard<sup>®</sup> zinc borate process resists mildew, rot and termite damage
- Pre-primed for weatherability
- Easy and safe to install using normal woodworking tools. No silica dust.

\*SURE LOCK: TRUWOOD'S UNIQUE CONCEALED NAILING SYSTEM

# Siding and Trim Specifications and Coverage

Siding Size	Thickness	Pieces / Bundle	Pieces / Unit	Maximum Exposure in inches	Sq. ft. Coverage / Piece	Actual	Approx. Coverage Sq. ft. / Unit*	Approx. Sq. ft. Needed to Cover 1000 Sq. ft. of Wall Area*	Approx. Weight Lbs. / Unit
<b>OLD MILL® LAP</b>									
6 in. x 16 ft. Bevel Edge Lap	7/16 in.	6	336	5	6.67	0.395 in. x 6 in. x 16 ft.	2128	1260	4420
8 in. x 16 ft. Bevel Edge Lap	7/16 in.	6	252	7	9.33	0.395 in. x 8 in. x 16 ft.	2234	1200	4440
9-1/2 in. x 16 ft. Bevel Edge Lap	7/16 in.	6	210	8-1/2	11.33	0.395 in. x 9.500 in. x 16 ft.	2261	1174	4405
12 in. x 16 ft. Bevel Edge Lap	7/16 in.	6	168	11	14.67	0.395 in. x 12 in. x 16 ft.	2341	1145	4490
12 in. x 16 ft. Bevel Edge (Smooth)	7/16 in.	6	168	11	14.67	0.395 in. x 12 in. x 16 ft.	2341	1145	4505
8 in. x 12 ft. Self-Aligning Lap	1/2 in.	5	210	7	9.33	0.485 in. x 8 in. x 16 ft.	1862	1200	3945
12 in. x 16 ft. Self-Aligning Lap	1/2 in.	5	140	11	14.67	0.485 in. x 12 in. x 16 ft.	1951	1145	4215
8 in. x 16 ft. Sure Lock	1/2 in.	5	210	7	9.33	0.485 in. x 8 in. x 16 ft.	1862	1200	4050
12 in. x 16 ft. Sure Lock Cottage Six Lap	1/2 in.	5	140	11	14.67	0.485 in. x 12 in. x 16 ft.	1951	1145	4260
12 in. x 16 ft. Sure Lock V-Rustic	1/2 in.	5	140	11	14.67	0.485 in. x 12 in. x 16 ft.	1951	1145	4120
12 in. x 16 ft. TwelveFour Cottage Lap	1/2 in.	5	140	11	14.67	0.485 in. x 12 in. x 16 ft.	1951	1145	3820
12 in. x 16 ft. TwelveSix Cottage Lap	1/2 in.	5	140	11	14.67	0.485 in. x 12 in. x 16 ft.	1951	1145	3910
16 in. x 16 ft. 4 in. Cottage Lap	1/2 in.	5	105	15	20	0.485 in. x 16 in. x 16 ft.	1995	1120	3940
16 in. x 16 ft. 5 in. Cottage Lap	1/2 in.	5	105	15	20	0.485 in. x 16 in. x 16 ft.	1995	1120	4150
16 in. x 16 ft. 8 in. Cottage Lap	1/2 in.	5	105	15	20	0.485 in. x 16 in. x 16 ft.	1995	1120	4150
16 in. x 16 ft. Channel Rustic	1/2 in.	5	105	15	20	0.485 in. x 16 in. x 16 ft.	1995	1120	3910
11-1/2 in. x 48-13/16 in. Old Mill® Shingle Lap	1/2 in.	6	140	9-3/4	3.25	0.485 in. x 11.5 in. x 48.81 in.	432	1238	1000
<b>CEDAR SHAKE LAP</b>									
10-1/2 in. x 16 ft. Self-Aligning	1/2 in.	5	140	9-1/2	12.67	0.485 in. x 10.5 in. x 16 ft.	1685	1161	3700
<b>DESIGNER SHAKE LAP</b>									
9-1/2 in. x 8 ft. Round	1/2 in.	6	90	6-3/4	4.5	0.485 in. x 9.5 in. x 8 ft.	385	1478	1050
9-1/2 in. x 8 ft. Fishscale	1/2 in.	6	90	7-1/2	5	0.485 in. x 9.5 in. x 8 ft.	428	1330	1050
9-1/2 in. x 8 ft. Octagon	1/2 in.	6	90	6-3/4	4.5	0.485 in. x 9.5 in. x 8 ft.	385	1478	1050
9-1/2 in. x 8 ft. Cove	1/2 in.	6	90	6-1/2	4.33	0.485 in. x 9.5 in. x 8 ft.	370	1535	1050
9-1/2 in. x 8 ft. Diamond	1/2 in.	6	90	4-1/4	2.83	0.485 in. x 9.5 in. x 8 ft.	242	2347	1050
9-1/2 in. x 8 ft. Craftsmen Staggered	1/2 in.	6	90	8	5.33	0.485 in. x 9.5 in. x 8 ft.	456	1247	1050
<b>OLD MILL® SOFFIT</b>									
7/16 in. Old Mill® Soffit	7/16 in.	6	126	16	21.33	0.395 in. x 16 in. x 16 ft.	2688	1050	4405
1/2 in. Old Mill® Soffit	1/2 in.	5	105	16	21.33	0.485 in. x 16 in. x 16 ft.	2240	1050	4250

Panel Style	Texture	Size	Pieces / Unit	Sq. ft. Coverage / Piece	Actual	Approx. Coverage Sq. ft. / Unit*	Approx. Sq. ft. Needed to Cover 1000 Sq. ft. of Wall Area*	Approx. Weight Lbs. / Unit
3/4 in. Channel Groove 8 in. O.C.	Old Mill®	7/16 in. x 48-13/16 in. x 7 ft.	45	28	0.395 in. x 48.81 in. x 7 ft.	1134	1100	2000
3/4 in. Channel Groove 8 in. O.C.	Old Mill®	7/16 in. x 48-13/16 in. x 8 ft.	45	32	0.395 in. x 48.81 in. x 8 ft.	1296	1100	2290
3/4 in. Channel Groove 8 in. O.C.	Old Mill®	7/16 in. x 48-13/16 in. x 9 ft.**	45	36	0.395 in. x 48.81 in. x 9 ft.	1458	1100	2560
Reverse Board & Batten	Old Mill®	7/16 in. x 48-13/16 in. x 8 ft.**	45	32	0.395 in. x 48.81 in. x 8 ft.	1296	1100	2340
Sturdy Panel 8 in. O.C. (Home Depot exclusive)	Old Mill®	7/16 in. x 48-13/16 in. x 8 ft.**	45	32	0.395 in. x 48.81 in. x 8 ft.	1296	1100	2300
3/8 in. Groove 8 in. O.C.	Old Mill®	7/16 in. x 4 ft. x 8 ft.	45	32	0.395 in. x 48.81 in. x 8 ft.	1296	1100	2300
Square Edge (Plain)	Old Mill®	7/16 in. x 4 ft. x 8 ft.	45	32	0.395 in. x 48 in. x 8 ft.	1296	1100	2485
Square Edge (Plain)	Smooth	7/16 in. x 4 ft. x 8 ft.	45	32	0.395 in. x 48 in. x 8 ft.	1296	1100	2485
3/8 in. Striated Groove 808 8 in. O.C.	Old Mill®	1/2 in. x 48-13/16 in. x 8 ft.	37	32	0.485 in. x 48.81 in. x 8 ft.	1066	1100	2270
Adobe™ Panel Siding Shiplap Edge	Adobe™	1/2 in. x 48-13/16 in. x 8 ft.	37	32	0.485 in. x 48.81 in. x 8 ft.	1066	1100	2270

Actual Size	Thickness	Pieces / Bundle	Pieces / Unit	Weight / Unit	Lineal ft. / Unit	Actual
2-1/2 in. x 16 ft.	3/4 in.	12	360	3340	5760	0.75 in. x 2.5 in. x 16 ft.
3-1/2 in. x 16 ft.	3/4 in.	8	240	3060	3840	0.75 in. x 3.5 in. x 16 ft.
5-1/2 in. x 16 ft.	3/4 in.	8	160	3250	2560	0.75 in. x 5.5 in. x 16 ft.
7-1/4 in. x 16 ft.	3/4 in.	4	120	3330	1920	0.75 in. x 7.25 in. x 16 ft.
9-1/4 in. x 16 ft.	3/4 in.	4	100	3440	1600	0.75 in. x 9.25 in. x 16 ft.
11-1/4 in. x 16 ft.	3/4 in.	4	80	3310	1280	0.75 in. x 11.25 in. x 16 ft.

Actual Size	Thickness	Pieces / Bundle	Pieces / Unit	Weight / Unit	Lineal ft. / Unit	Actual
2-1/2 in. x 16 ft.	1 in.	9	324	3960	5184	0.960 in. x 2.5 in. x 16 ft.
3-1/2 in. x 16 ft.	1 in.	6	216	3820	3456	0.960 in. x 3.5 in. x 16 ft.
5-1/2 in. x 16 ft.	1 in.	6	144	3780	2304	0.960 in. x 4.5 in. x 16 ft.
7-1/4 in. x 16 ft.	1 in.	3	108	3940	1728	0.960 in. x 7.25 in. x 16 ft.
9-1/4 in. x 16 ft.	1 in.	3	90	4150	1440	0.960 in. x 9.25 in. x 16 ft.
11-1/4 in. x 16 ft.	1 in.	3	72	4030	1152	0.960 in. x 11.25 in. x 16 ft.

Actual Size	Thickness	Pieces / Bundle	Pieces / Unit	Weight / Unit	Lineal ft. / Unit	Actual
7-1/4 in. x 16 ft.**	3/4 in.	4	120	3200	1920	0.75 in. x 7.25 in. x 16 ft.

## TRUWOOD NOTES

### LAP SIDING

\* Allows for 1 in. overlap and assumes a 5% waste factor.

### PANEL SIDING AND SOFFIT

\* Assumes a 10% waste factor for cutting and fitting.

All grooved panels are shiplapped on the long edges and cut oversize to provide 48 in. net coverage when applied.

Adobe panels are shiplapped on the long edges and cut oversize to provide 48 in. net coverage when applied.

\*\* Limited availability

### PLOWED FASCIA

\*\* Old Mill® face, plowed on the back side.

# PRODUCT PROFILES

## CEDAR SHAKE LAP SIDING (16 ft. LENGTHS)

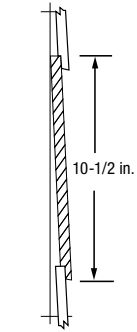

Self-Aligning Cedar Shake  
1/2 in. Lap Siding  
12.67 sq. ft. coverage/piece

## BEVEL EDGE LAP SIDING (16 ft. LENGTHS)

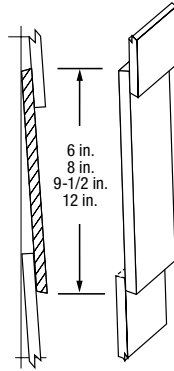

6 in. - 6.67  
8 in. - 9.33  
9-1/2 in. - 11.33  
12 in. - 14.67  
sq. ft. coverage/piece

Bevel Edge  
7/16 in. Lap Siding

## SELF-ALIGNING LAP SIDING (16 ft. LENGTHS)

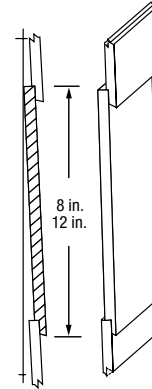

8 in. - 9.33  
12 in. - 14.67  
sq. ft. coverage/piece

Self-Aligning  
1/2 in. Lap Siding

## SELF-ALIGNING COTTAGE LAP® SIDING (16 ft. LENGTHS)

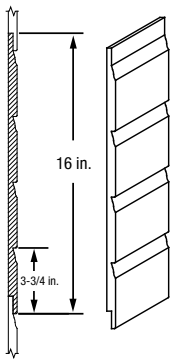

4 in. Cottage Lap  
7/8 in. Groove  
1/2 in. Lap Siding  
20 sq. ft. coverage/piece

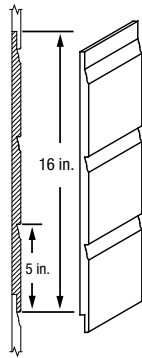

5 in. Cottage Lap  
7/8 in. Groove  
1/2 in. Lap Siding  
20 sq. ft. coverage/piece

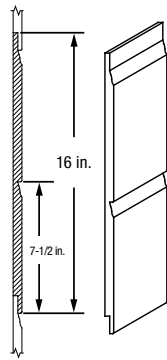

8 in. Cottage Lap  
7/8 in. Groove  
1/2 in. Lap Siding  
20 sq. ft. coverage/piece

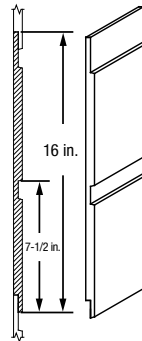

Channel Rustic  
1 in. Groove  
1/2 in. Lap Siding  
20 sq. ft. coverage/piece

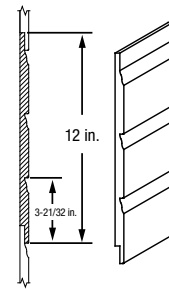

TwelveFour  
Cottage Lap  
7/8 in. Groove  
1/2 in. Lap Siding  
14.67 sq. ft. coverage/piece

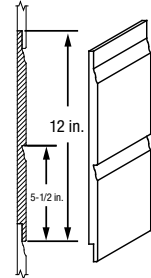

TwelveSix  
Cottage Lap  
7/8 in. Groove  
1/2 in. Lap Siding  
14.67 sq. ft. coverage/piece

## DESIGNER SHAKE® SIDING (8 ft. LENGTHS)

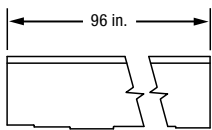

Designer Shake  
Craftsmen Staggered  
1/2 in. Lap Siding  
5.33 sq. ft. coverage/piece

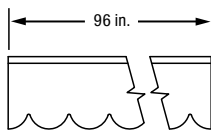

Designer Shake  
Round  
1/2 in. Lap Siding  
4.5 sq. ft. coverage/piece

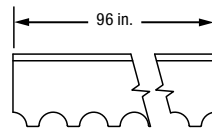

Designer Shake  
Cove  
1/2 in. Lap Siding  
4.33 sq. ft. coverage/piece

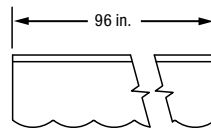

Designer Shake  
Fishscale  
1/2 in. Lap Siding  
5 sq. ft. coverage/piece

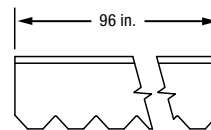

Designer Shake  
Octagon  
1/2 in. Lap Siding  
4.5 sq. ft. coverage/piece

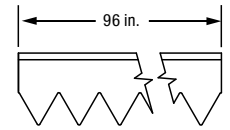

Designer Shake  
Diamond  
1/2 in. Lap Siding  
2.83 sq. ft. coverage/piece

# PRODUCT PROFILES

## PANEL SIDING (4 ft. x 8 ft. PANELS) & SOFFIT (16 in. x 16 ft.)

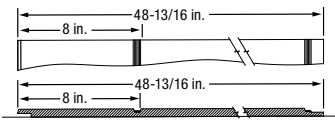

1/2 in. Old Mill® 808 Striated Groove  
7/16 in. 3/8 in. Groove  
7/16 in. Sturdy Panel  
32 sq. ft. coverage/piece

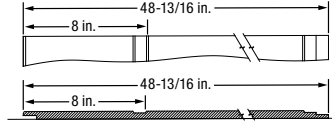

7/16 in. Old Mill®  
8 in. O.C. Channel Groove - 3/4 in. Groove  
(also available in. 4 ft. x 7 ft. and 4 ft. x 9 ft. panels)  
32 sq. ft. coverage/piece

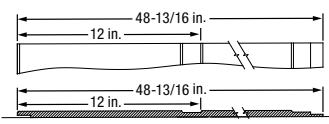

7/16 in. Old Mill®  
12 in. Reverse Board and Batten -  
1-3/16 in. Groove  
32 sq. ft. coverage/piece

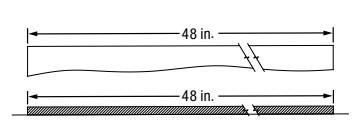

7/16 in. Old Mill® Square Edge  
7/16 in. Smooth Square Edge  
32 sq. ft. coverage/piece

## ADOBE® PANEL SIDING (4 ft. x 8 ft. PANELS)

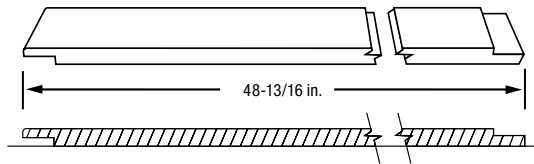

Adobe 1/2 in. Panel Siding Shiplapped Edge  
32 sq. ft. coverage/piece

## OLD MILL® SHINGLE LAP SIDING

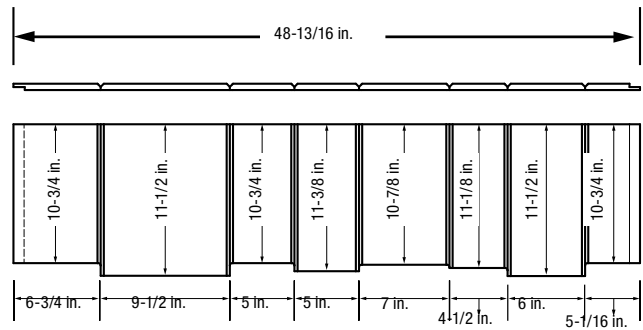

1/2 in. Old Mill® Shingle Lap  
3.25 sq. ft. coverage/piece

## SURE LOCK™ LAP SIDING WITH CONCEALED NAILING SYSTEM (16 ft. LENGTHS)

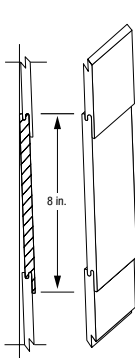

8 in. Sure Lock  
1/2 in. Lap Siding  
9.33 sq. ft. coverage/piece

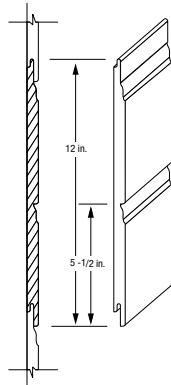

Sure Lock Six Cottage Lap  
7/8 in. Groove  
1/2 in. Lap Siding  
14.67 sq. ft. coverage/piece

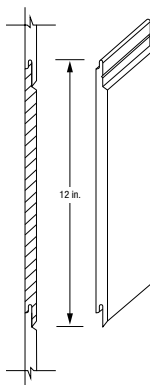

12 in. Sure Lock V-Rustic  
3/8 in. Groove  
1/2 in. Lap Siding  
14.67 sq. ft. coverage/piece

## TRIM / FASCIA (16 ft. LENGTHS)

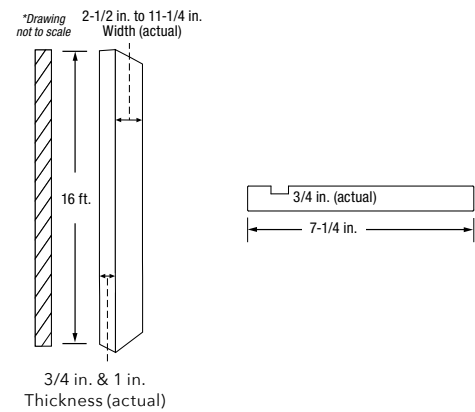

For more information about TruWood Siding and Trim, including warranty and installation instructions, or to view our Visualizer tool, please call **800.417.3674** or visit [TruWoodSiding.com](http://TruWoodSiding.com).

**TruWood Siding and Trim meet the requirements of the following:**  
2024 International Building Code | 2024 International Residential Code | ICC ESR-2588  
ANSI A135.6-2012 (R2020) | Wildland-Urban Interface (WUI) Approved\*

\*WUI APPLICATION REQUIREMENTS • Framing must not exceed 16 in. on center.  
• Minimum 5/8 in. Type-X gypsum exterior sheathing is required.



Follow TruWood® Siding or Trim installation instructions.

Ask us about ValuForm® concrete forming products.