



Installation Instructions for TruWood Trim

Important:

Read and understand all pages of the installation instructions before starting the trim application.

For TruWood care and maintenance information, warranty information, and installation videos, visit our web site at: TruWoodSiding.com

USES FOR TRUWOOD TRIM

Truwood Trim is a non-structural decorative trim product. TruWood Trim may be used for all of the following trim applications:

- Fascia
- Rake board
- Frieze board
- Belly band
- Window trim (not to be used for window sills)
- Corners
- Column wrap
- Board and Batten
- Door trim

VAPOR BARRIERS, VENTILATION AND MOISTURE CONTROL

- Roofs, gutters, roof to wall transitions, windows, doors, decks and attachments shall be designed, flashed and installed to prevent moisture entry into the trim or wall cavity or accumulation of water against the trim other than ambient moisture.
- Trim must have 2 in. clearance from masonry, concrete, brick, stone, stucco or mortar, or be separated by metal flashing.
- A continuous vapor barrier rated 1 perm or less is required across the interior side of all walls to be sided.
- A vapor barrier rated 1 perm or less must be installed between the wood sill, wood framing and the foundation wall.
- A vapor barrier ground cover must be used in crawl spaces.
- Crawl spaces, attics and living spaces must be ventilated at least to the minimum specified in HUD standards.

FLASHING

- In areas where the bottom drip edge of the trim is adjacent to flashing, provide a minimum 3/8 in. gap between bottom drip edge of the trim and the flashing.
- Install flashing in a manner that creates proper out-sloping (see Fig. 4 and 5).
- Kick out flashing is required in areas where the roof and gutters are adjacent to the siding. Provide a 1 in. clearance between the gutter end and trim (see Fig. 7).

CUTTING

- Cut with conventional tools into the face to be exposed.
- Make sure to prime and paint all cut edges.
- Do not miter sides (edges) of trim. If trim is cut to fit around door and window openings, raw edges of trim must be primed and painted or sealed with approved sealant (see Fig. 6).
- 45 degree diagonal cuts are permitted around door and window openings (see Fig. 6).

FASTENING

- Use corrosion resistant boxhead nails with a minimum head diameter of 1/4 in. (10% variance allowed).
- Nail on each edge 12 in. o.c. alternating edges with nails placed a minimum of 1/2 in. from trim edge.
- Nails must penetrate wood framing 1-1/2 in.
- Fascia and rake boards must be applied over framing members that will allow proper nailing.
- Avoid countersinking nails or rupturing the surface of the siding. If countersinking occurs, seal nail prior to painting (see Fig. 1).
- Do not nail into trim edges.
- Fasten from end to end or center to end to avoid internal stress.
- Battens that do not fall over framing members must be applied with a ring shank nail.

- Butt joints must be located on framing members.
- When a scarf joint is used, two nails are required into solid wood framing on each side of the joint (see Fig. 2).

BUTT JOINTS

- All butt joints must be located over studs.
- Leave 3/16 in. gap at all butt joints.
- Metal joint covers are recommended at all butt joints and corners. This method minimizes long-term homeowner maintenance.
- In lieu of metal joint covers, seal the joint with the recommended sealant.

CLEARANCES

- Trim must have a minimum 2 in. separation from concrete, masonry, stucco, brick, mortar and stone or be separated by appropriate metal flashing.
- Trim must be 6 in. from soil or landscaping material.
- Where the trim meets the roof, it must be spaced a minimum of 2 in. from the plane of the roof and be properly flashed. The cut edge must be primed and painted.
- Vegetation must not be in direct contact with the trim.

SEALING

- Use the best quality flexible, paintable, mildew-resistant exterior grade sealant material that meets ASTM C920, Class 25 or higher.
- Seal around all openings such as window and door frames and at butt joints.
- Seal all overdriven nails (see Fig. 1).
- Seal or flash all horizontal trim material in a manner that creates proper out-sloping.

PAINTING

- Touch up damaged areas with premium acrylic latex primer or premium alkyd oil-based primer.
- Trim must be finish-painted within 90 days after installation. If trim is exposed for a longer period, reprime the trim.
- Trim must be clean and dry when paint is applied.
- Use only premium acrylic latex paint or premium alkyd oil-based paint containing an appropriate amount of mildewcide for local moisture conditions.
- For best performance, use 100% acrylic latex paints or 100% acrylic latex solid body (opaque) stain.
- Follow paint manufacturer's recommendations for engineered wood trim.
- A minimum of 4 dry mils, which includes 1 mil factory primer, is required. This is best achieved with two coats of finished paint.
- All cut ends must be well coated with primer and paint or sealant.

PROPER STORAGE

- Store trim flat and support it on stringers to avoid sagging and contact with the ground.
- Trim must be covered and protected from the elements.
- Allow trim to acclimatize to local conditions prior to installation.
- Do not re-manufacture the trim by ripping or routing.

CONSTRUCTION ESSENTIALS

- The structure must be constructed to meet local applicable building requirements, HUD minimum property standards or HUD manufactured housing construction and safety standards. Trim does not provide shear strength.

WARRANTY REQUIREMENTS

- The terms of the Limited Warranty require strict compliance with the installation instructions. These instructions are supplemental to applicable local building codes and standard building practices. Compliance with the most stringent of these is required. Architectural designs, plans and specifications must comply with these instructions.
- All deviations from the installation instructions must be pre-approved in writing by the Collins Products LLC Product Performance Manager.

INSTALLATION ERRORS THAT VOID THE WARRANTY

- Do not apply trim to a rain soaked structure.
- Trim should not be used to construct window sills.
- Do not apply trim that is wet. Wet trim can shrink after application and shrinkage is not covered by the TruWood warranty.
- Wet blown insulation is not allowed.
- Do not apply stucco or composite stucco products over the trim.
- Do not apply the trim to floating structures or buildings over water.
- Staples are not an acceptable fastening device.
- Do not apply to wall systems without conventional framing.
- Do not paint in wet or cold conditions.
- Do not use shake and shingle paints, low quality flat oil or alkyd paints, vinyl acetate (PVA), vinyl acrylic or vinyl acetate-acrylic co-polymer paints. These coatings do not adequately protect the trim.
- Do not remanufacture the trim by ripping or routing.

Note: This list is not intended to be inclusive of all errors that would void the warranty. These are just some examples.

KEY HOMEOWNER MAINTENANCE RESPONSIBILITIES

- Inspect and renew all sealant and immediately repair any water penetration issues every year.
- Maintain gutters and downspouts to avoid water cascading down walls.
- Ensure sprinkler patterns are directed away from structures.
- Follow paint manufacturer's recommendations for repainting and paint maintenance.

CODES AND STANDARDS

- TruWood Trim is designed to be used in compliance with all applicable building codes and standards.

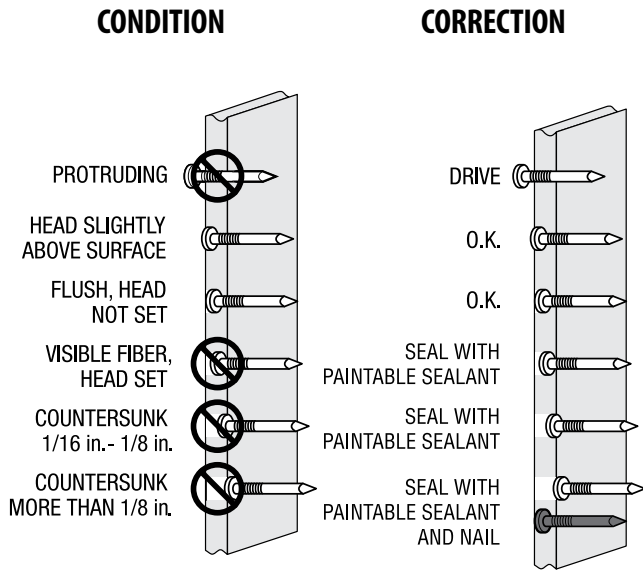

Figure 1

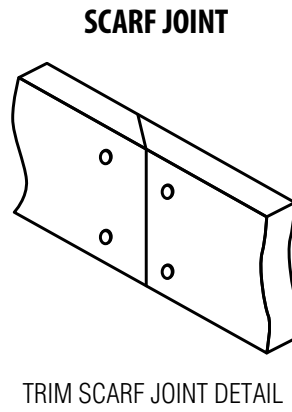

Figure 2

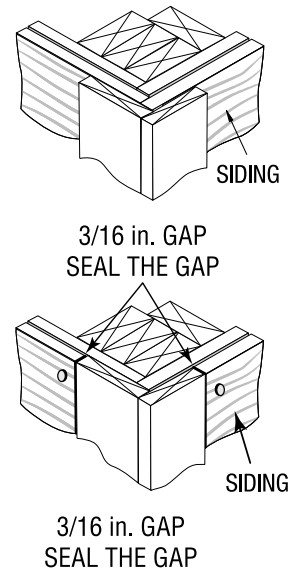

Figure 3

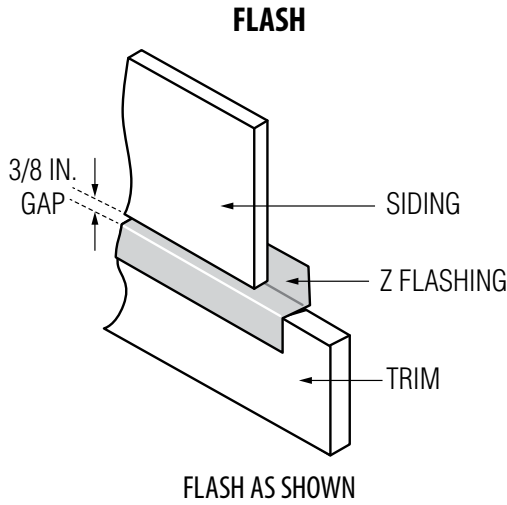

Figure 4

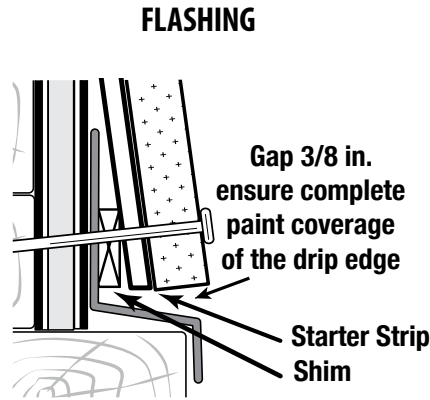

Figure 5

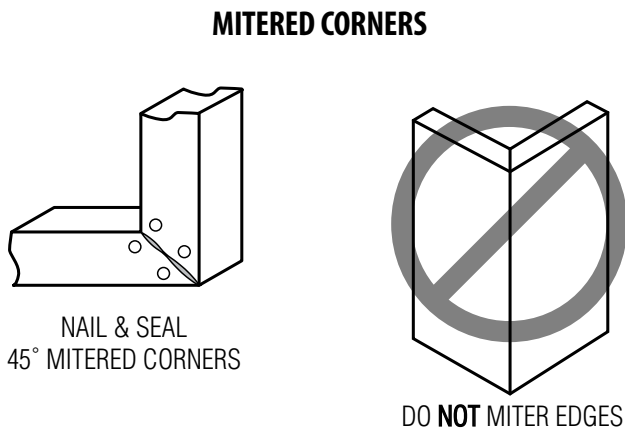

Figure 6

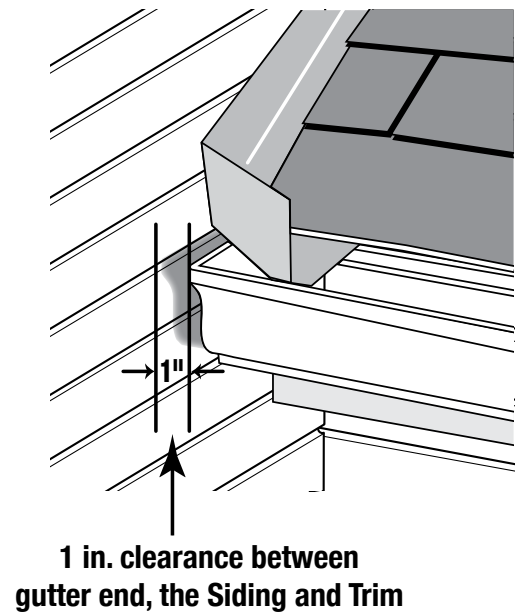
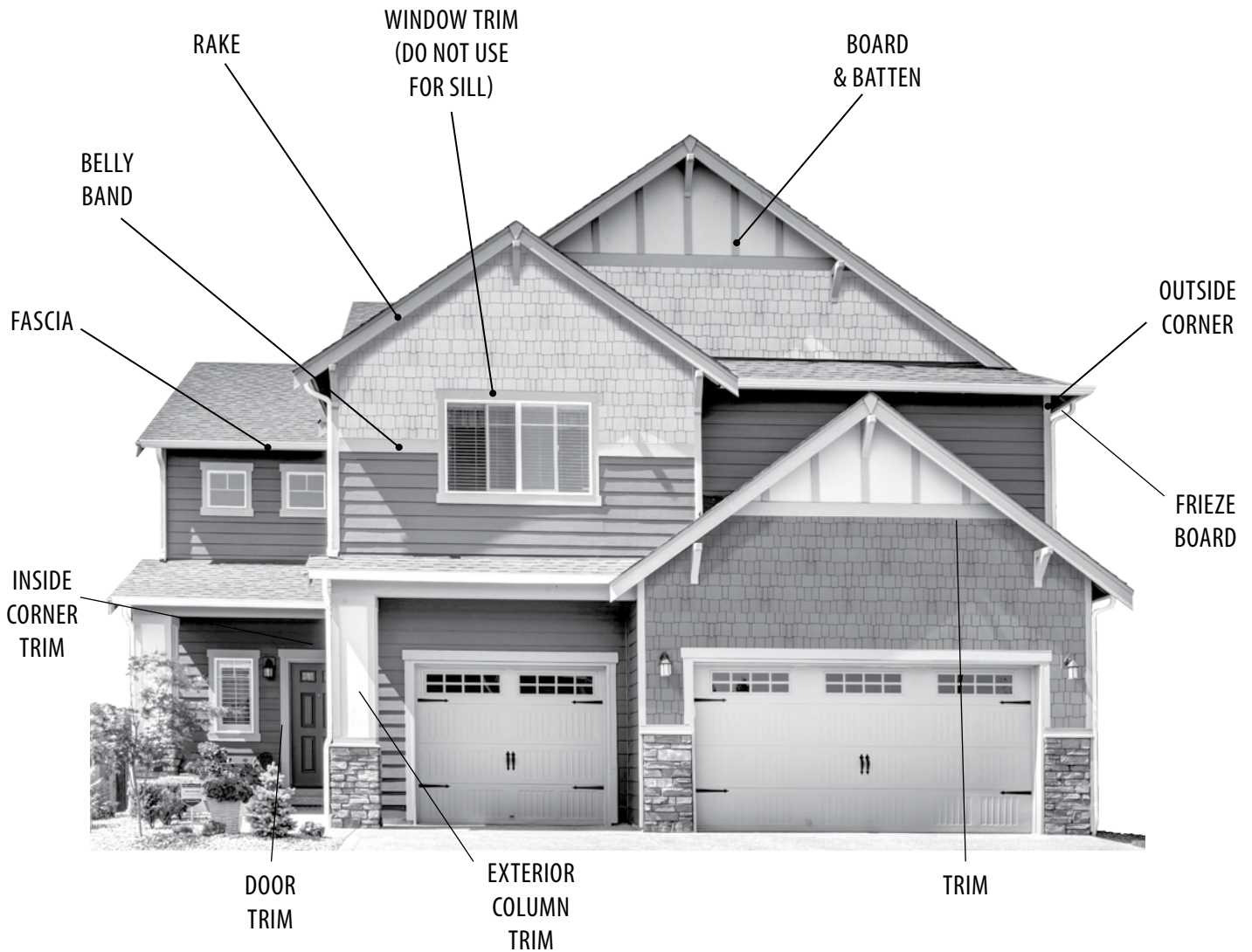

Figure 7



- Nails must penetrate wood framing 1-1/2 in.
- Do not use staples. Use only the nails specified in these instructions.
- Install a minimum 3/16 in. gap at butt joints and ends. Use only approved methods to protect joints areas.
- Trim must not be in direct contact with stucco, mortar, stone, brick, concrete or masonry.
- Apply trim in a method that will prevent moisture entry into the trim, siding or wall cavity.
- **Seal all exposed cut ends** using a method that will prevent moisture intrusion.
- Maintain the proper clearance from the trim bottom edge to the finished grade, walkways and adjacent to the roof lines.

Sales: 800.417.3674 • Warranty: 800.329.1219 • TruWoodSiding.com